

1
Assemble
poles

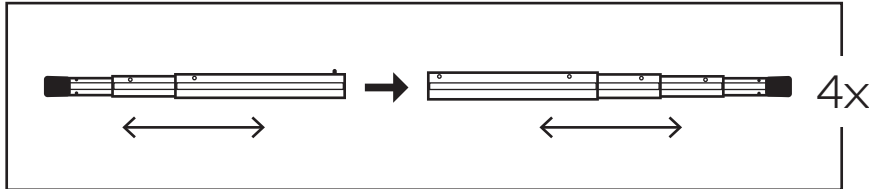

2
Connect pole ends
with ball loops
and carabiners

Connect baseline
and ridgeline

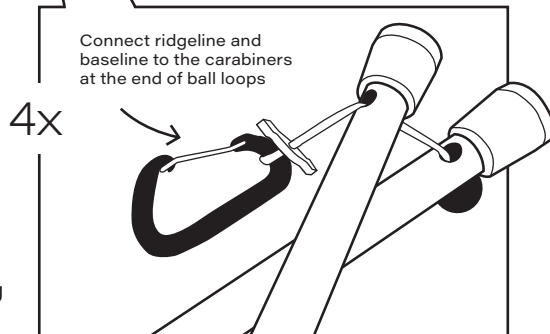
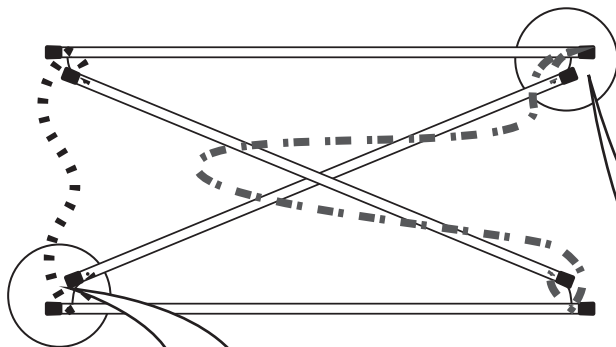

! Thread connection
so ball is outside
and carabiner is
inside pole crossing

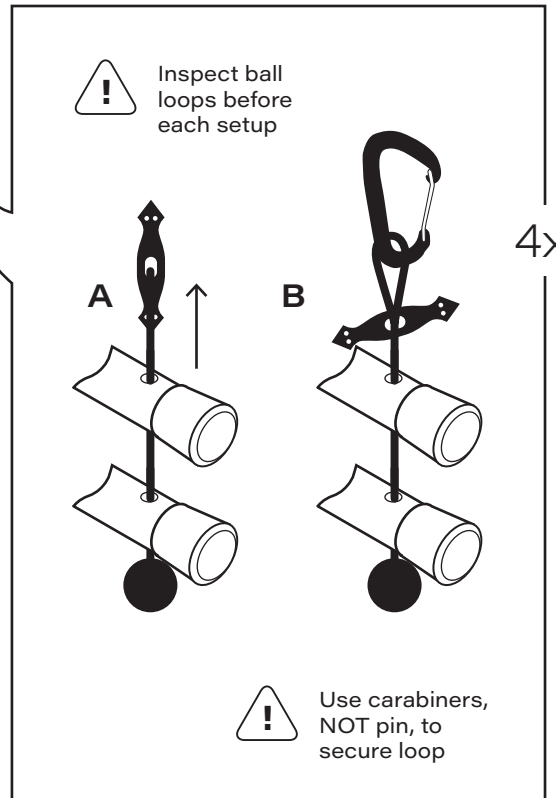

! Inspect ball
loops before
each setup

! Use carabiners,
NOT pin, to
secure loop

3
Spread baseline
and add
foot anchor

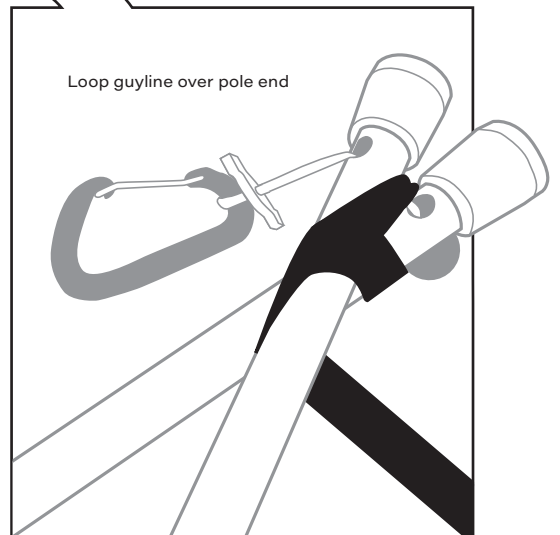
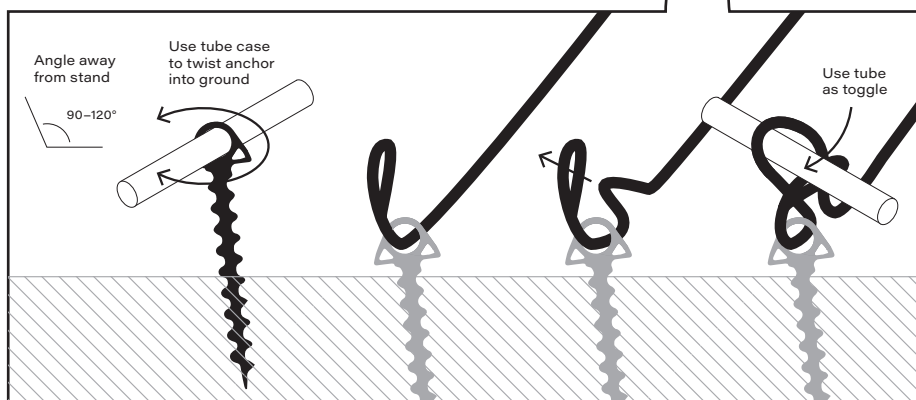
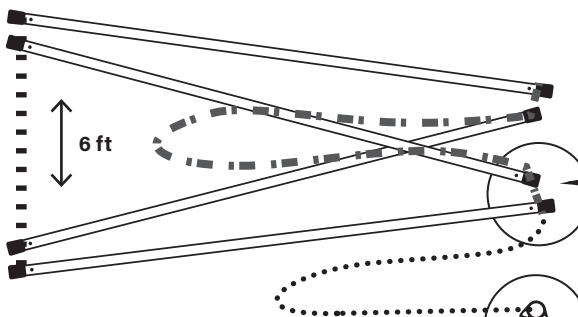

Loop guyline over pole end

4

Erect stand

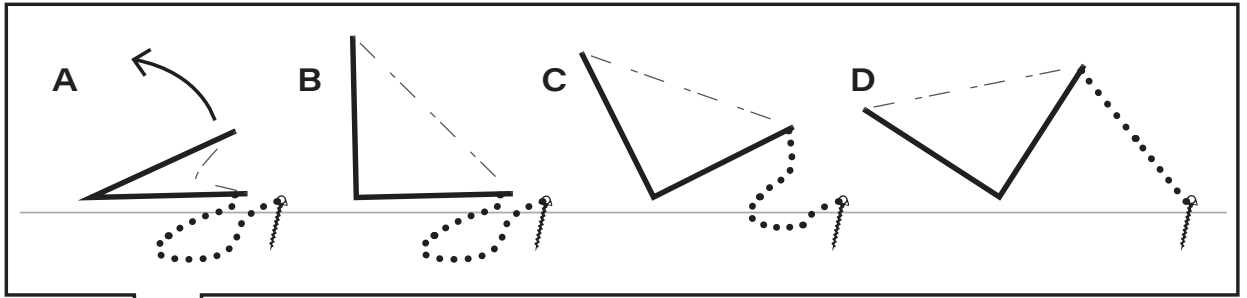

! Head end MUST be lower than foot end

Head end

Foot end

Ridgeline

Guyline

5

Add head guyline

(optional)

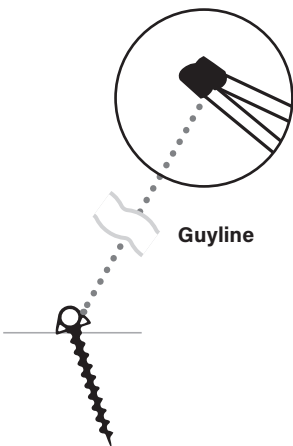

Guyline

Baseline

6

Attach hammock

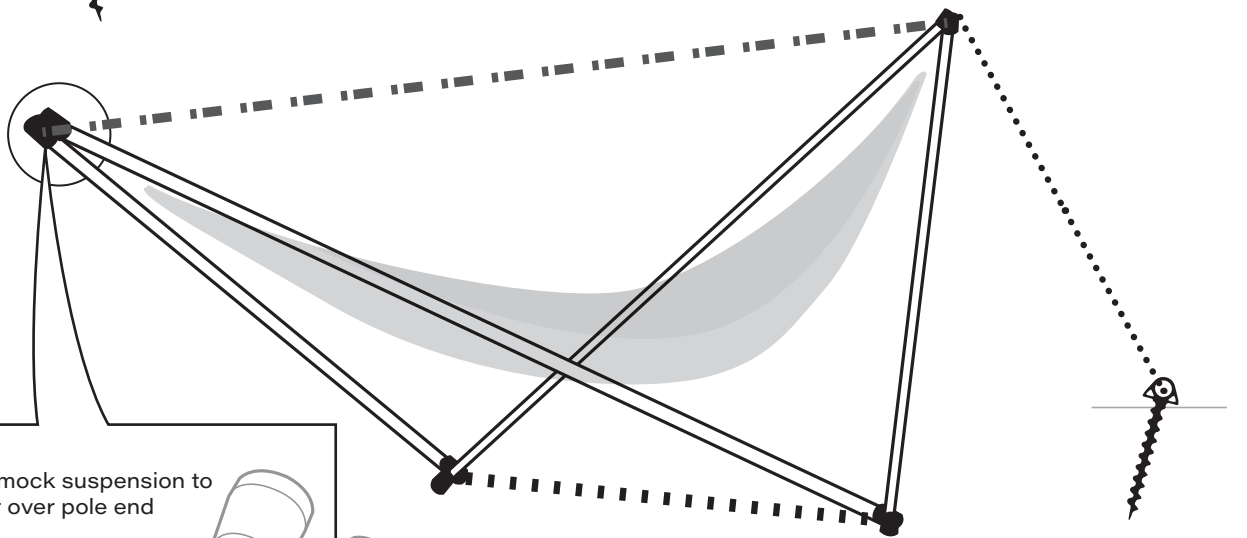

!

Attach hammock suspension to carabiner or over pole end

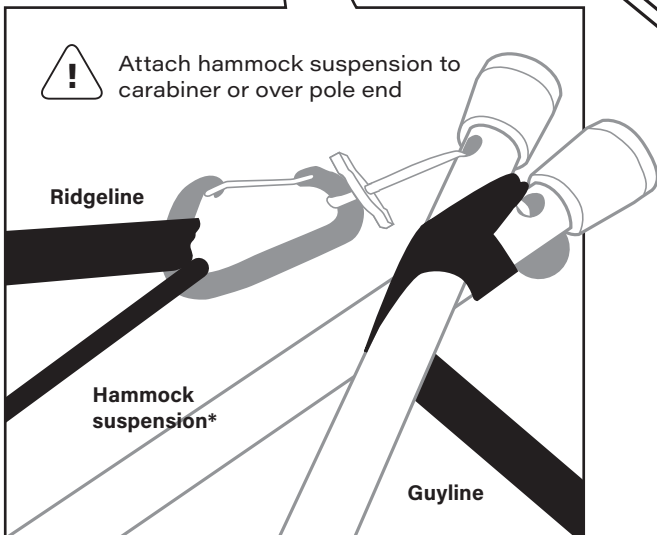

Ridgeline

Hammock suspension*

Guyline

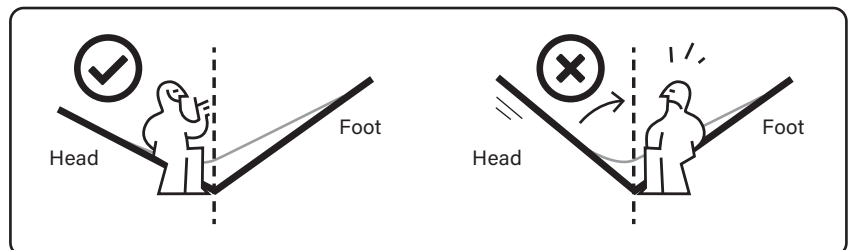

Head

Foot

Head

Foot

*Hammock and hammock suspension not included



Snap this QR code for setup videos and tips

